

 1390	FAKRO PP Sp. z o.o. ul. Węgierska 144a 33-300 Nowy Sącz Polska (Poland/Polen/Polognie)	Rok wprowadzenia Year of issue Einführungsjahr Année de lancement 12
	EN 14351-1:2006+A1:2010	

(PL) Drewniany wyłaz dachowy przeznaczony do zastosowania w lokalizacjach mieszkalnych i handlowych (na poddaszach nieużytkowych i nieogrzewanych). (GB) Wooden access roof light intended to be used in domestic and commercial spaces (in non-habitable lofts). (DE) Ausstiegsfenster aus Holz, geeignet für Wohn- und Gewerberäume (unbewohntes und unbeheiztes Dachgeschoss). (FR) La fenêtre d'accès au toit en bois est conçu pour être monté dans les bâtiments privés et publics (dans les locaux d'habitation et dans les pièces froides).	WLI Klasa C4 Class C4 Klasse C4 Classe C4
Odporność na obciążenie wiatrem Resistance to wind load Widerstandsfähigkeit gegen Windlast Résistance à la force du vent	Klasa C4 Class C4 Klasse C4 Classe C4
Odporność na obciążenie śniegiem Resistance to snow load Widerstandsfähigkeit gegen Schneelast Résistance à la force de la neige	4H-8-4H ⁽¹⁾
Reakcja na ogień Reaction to fire Brandverhalten Réaction au feu	npd ⁽²⁾
Odporność na działanie ognia zewnętrznego External fire performance Schutz gegen Brand von Außen Résistance au feu extérieur	npd
Wodoszczelność. Nieosłonięte (A) Watertightness. Non-shielded (A) Schlagregendichtheit, umgeschützt (A) Etanchéité à l'eau. Sans protection (A)	5A
Odporność na uderzenie [mm] Impact resistance [mm] Stoßfestigkeit [mm] Résistance aux chocs [mm]	npd
Nośność urządzeń zabezpieczających Load-bearing capacity of safety device Tragfähigkeit von Sicherheitsvorrichtungen Performances des dispositifs de protection	wartość progowa Threshold value Schwellenwert Valeur du seuil
Właściwości akustyczne Acoustic performance Schallschutz Performances acoustiques	[dB] npd
Przenikalność ciepła okna Thermal transmittance Wärmedurchgangskoeffizienten Transmission de la chaleur de la fenêtre	Uw [W/m2K] npd
Właściwości związane z promieniowaniem: Współczynnik promieniowania słonecznego g Radiation properties: Solar factor g Strahlungseigenschaften: Gesamtenergiedurchlassgrad g Propriétés liées aux rayonnements: Coefficient du rayonnement solaire g	0,77
Właściwości związane z promieniowaniem: Przenikalność światła Radiation properties: Light transmittance Strahlungseigenschaften: Lichttransmissionsgrad Propriétés liées aux rayonnements: Transmission de la lumière	0,81
Przepuszczalność powietrza Air permeability Luftdurchlässigkeit Etanchéité à l'air	Klasa 2 Class 2 Klasse 2 Classe 2
Deklaracja właściwości użytkowych Declaration of Performance Leistungserklärung Déclaration des performances	W40/CPR/14351/13 01.07.2013

⁽¹⁾ H – szyba hartowana, ⁽²⁾ npd – właściwości użytkowe nieustalone (no performance determined)
⁽¹⁾ H – toughened glass, ⁽²⁾ npd – no performance determined
⁽¹⁾ H – Einscheiben-Sicherheitsglas, ⁽²⁾ npd – keine Leistung festgestellt (no performance determined)
⁽¹⁾ H – vitre trempée, ⁽²⁾ npd – (no performance determined) – performances non déterminées



WLI

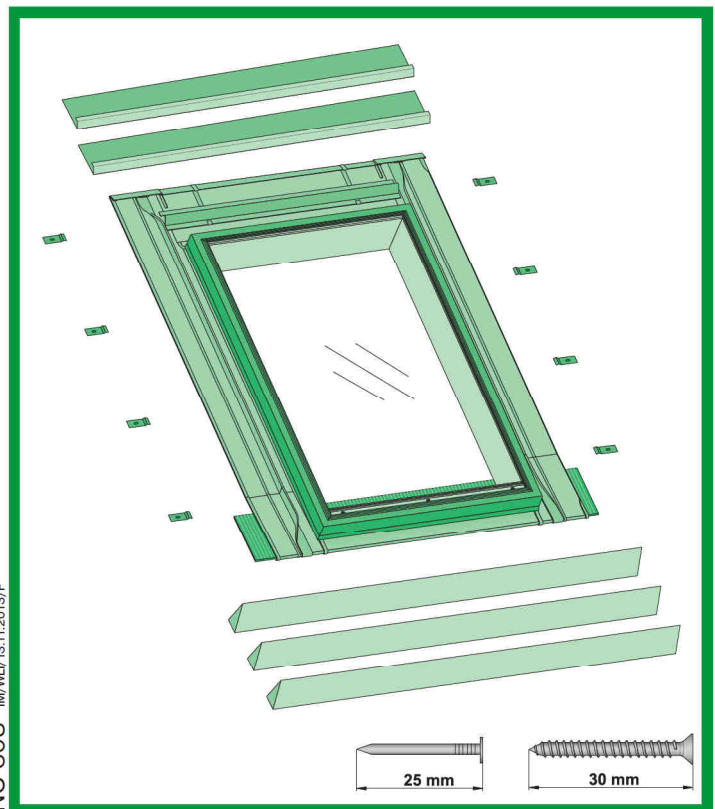
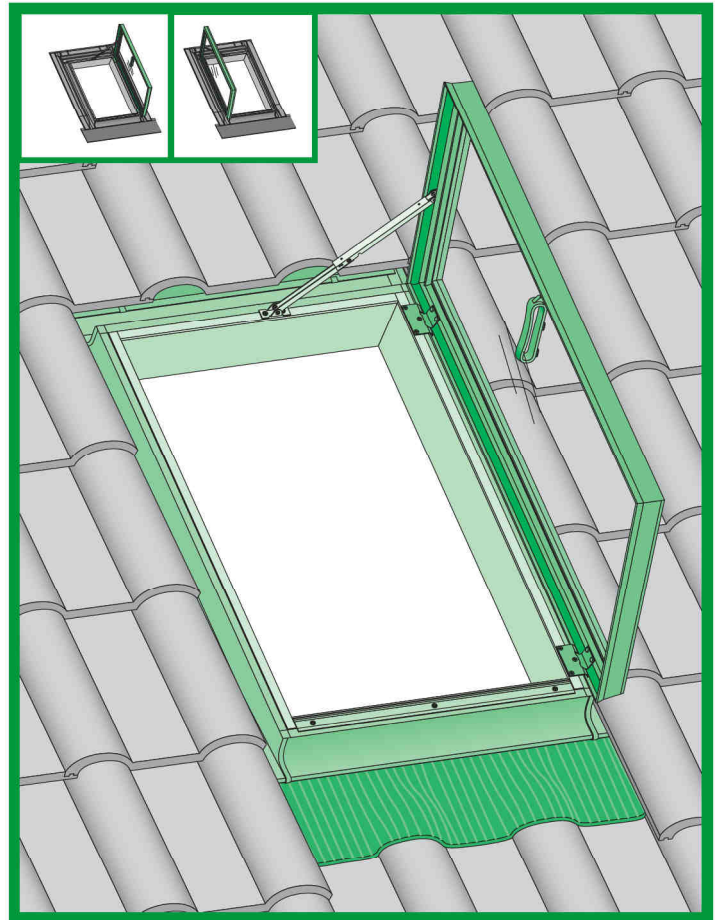



DEKLARACIJA ZA EKSPLOATACIONNI POKAZATELI - PROHLÁSENÍ O VLASTNOSTECH - LEISTUNGSERKLÄRUNG - YDEEVNEKLARATION - TOIMIVUOSDEKLARATSIIOON - DECLARACIÓN DE PRESTACIONES - DÉCLARATION DES PERFORMANCES - DECLARATION OF PERFORMANCE - IZJAVA O SVOJSTVIMA - TELJESTIMÉNYILATKOZAT - DICHIARAZIONE DI PRESTAZIONE - EKSPLOATACIJU SAVVIJU DEKLARACIJA - EKSPLUATÁCIJAS ÍPÁŠĪBU DEKLARÁCIJA - PRESTATIVERKLARING - YTLESERKLÆRING - DEKLARACIJA WŁAŚCIWOŚCI UŻYTKOWYCH - DECLARAÇÃO DE DESEMPENHO - DECLARAȚIE DE PERFORMANȚĂ - PRESTANDADECLARATION - IZJAVA O LASTNOSTIH - VYHLÁSENIE O PARAMETROCH



<http://www.fakro.com/download/declarations-of-performance>

CZ Výrobce a Prodávce nesešádnou odpovědnost za nedodržení příslušných předpisů zákona, stavebních předpisů a bezpečnostních požadavků plus uživatele výrobku, architekta, montážní nebo majitele objektu. Hersteller und Verkäufer übernehmen keine Haftung für Nichtbeachtung entsprechender Rechts- und Bauvorschriften sowie Sicherheitsanforderungen seitens Produktbenutzers, Architekten, Monteurs oder Gebäudebesitzers. El fabricante y el vendedor no tienen ninguna responsabilidad por el incumplimiento de la ley vigente, normas de construcción y exigencias de seguridad por parte del usuario del producto, arquitecto, instalador o el propietario del edificio. Le fabricant et le vendeur ne prend aucune responsabilité de ne pas respecter les lois applicables, les règlements sur les bâtiments et les exigences de sécurité par l'utilisateur du produit, l'architecte, l'installateur ou le propriétaire du bâtiment. Manufacturer and Seller shall bear no liability for failure to comply with the applicable laws, building codes and safety requirements by the user of the product, architect, fitter or owner of the building. A gyártó és a forgalmazó nem vállal semmilyen felelősséget a vonatkozó törvényi, építési és biztonsági előírások, tervek, építési, beszállómaster vagy építésmunkások által be nem tartásáért. Il Produttore e il Rivenditore non potranno essere ritenuti responsabili per il mancato rispetto da parte dell'utente del prodotto, del progettista, dell'installatore o del proprietario dell'edificio, delle leggi vigenti, nonché dei regolamenti edilizi e di quelli relativi alla sicurezza.	NL De fabrikant en verkoper zijn niet aansprakelijk voor gevolgen bij het niet opvolgen van toepasselijke wetten, bouwbesluiten en veiligheidsvoorschriften door de gebruiker van het product, de architect, de installateur of de eigenaar van het gebouw. Producător și vânzător nu pot primi răspundere pentru nerespectarea cerințelor legale, cerințelor de construcție și cerințelor de siguranță impuse utilizatorilor produsului, arhitecților, montajistilor sau proprietarilor clădirii. В случае несоблюдения архитектором, монтажником или владельцем здания строительных правил и норм безопасности ответственность с производителя и продавца снимается. Výrobca a predávca nenesú žiadnu zodpovednosť za nedodržanie príslušných ustanovení zákona, stavebných predpisov a bezpečnostných požiadaviek užívateľom výrobku, architektom, montážom alebo majiteľom objektu.
---	--

NC 308 IM/WLI/13.11.2013/F

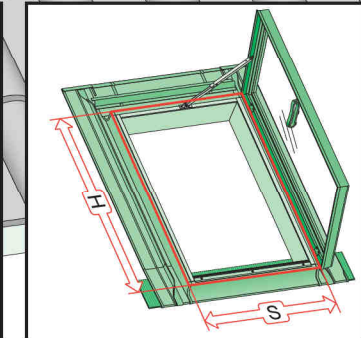
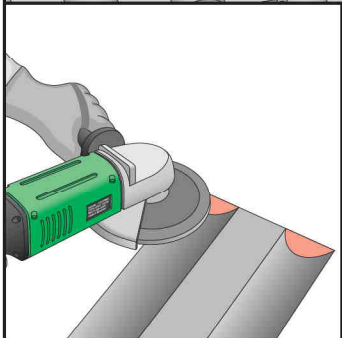
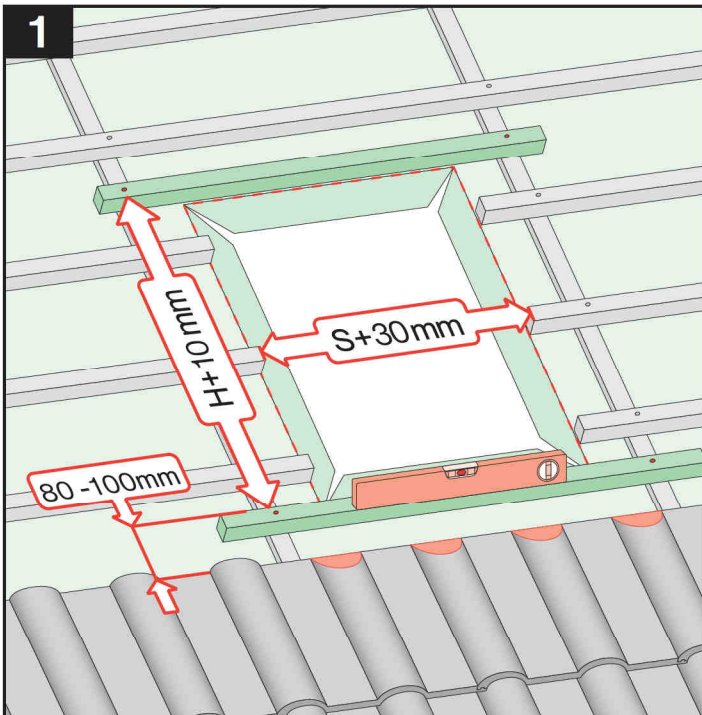
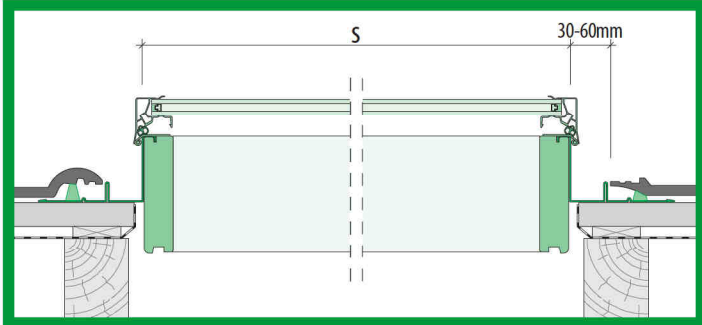
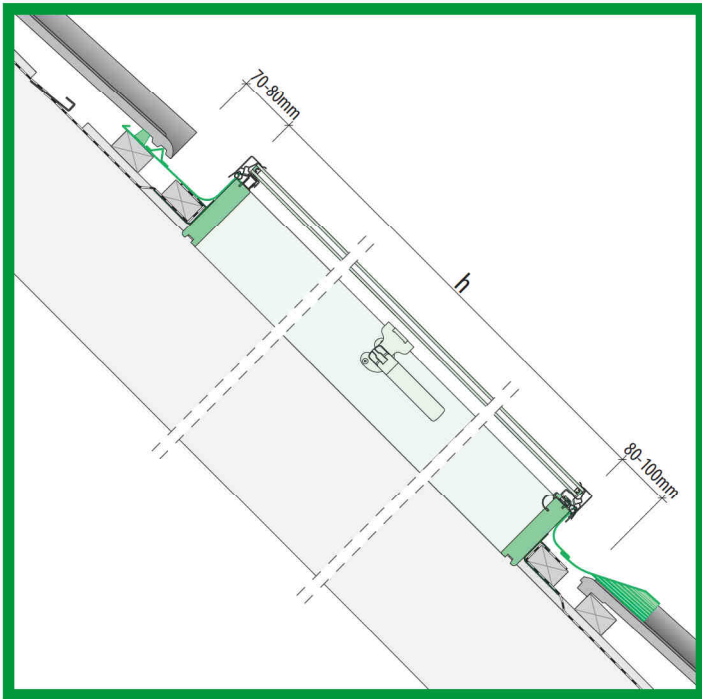

2

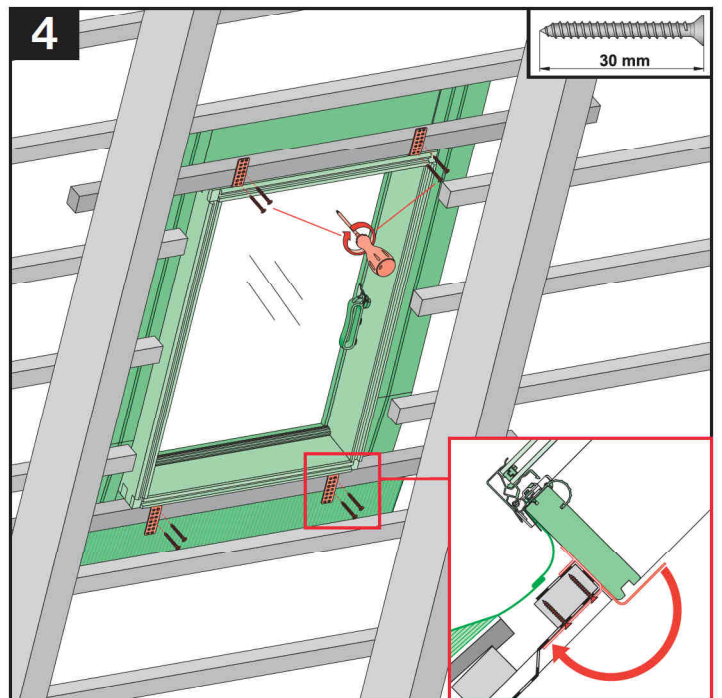
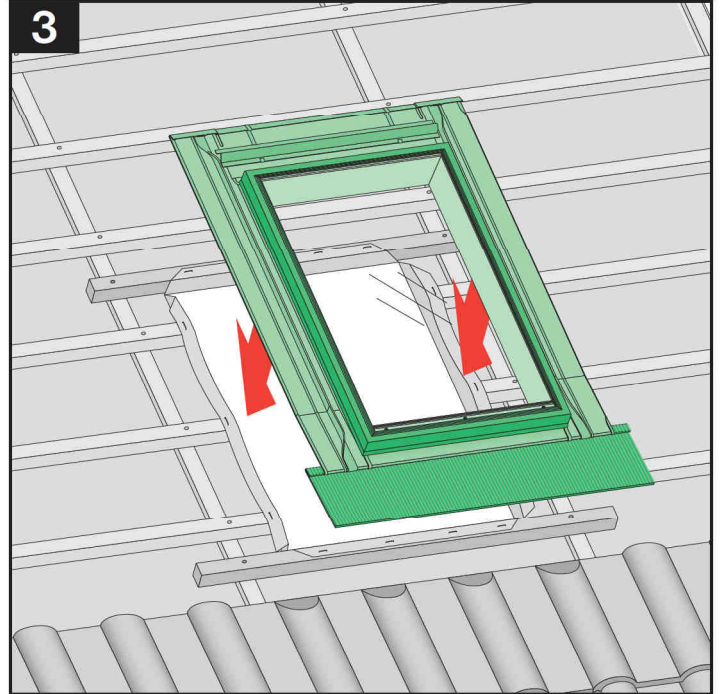
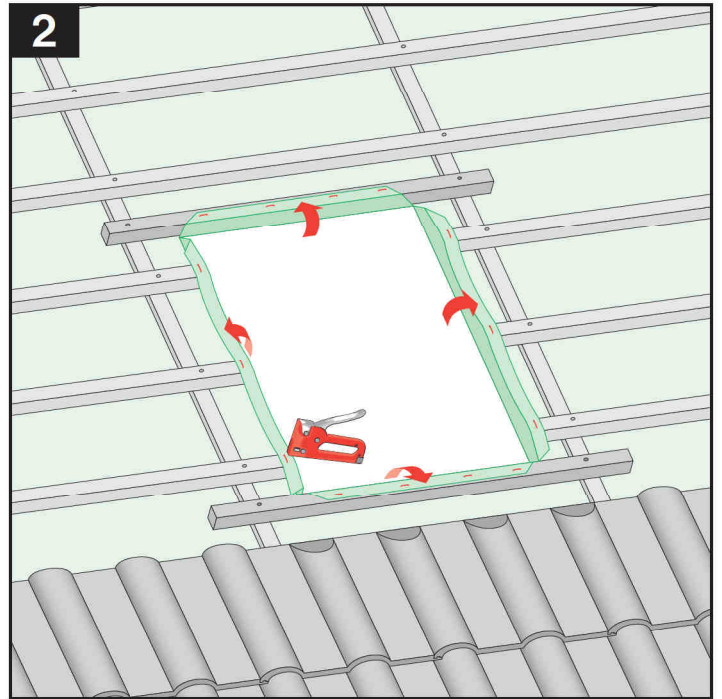

3

